

# ***K*** **KARTÓDROMO** **ARENA DE ITU**

## **Manual para Eventos**



**Arena Multiuso**

# Estrutura

- ✓ 70.000 mts<sup>2</sup>
- ✓ Topografia plana em nível com o logradouro
- ✓ Arquibancada fixa
- ✓ 60 boxes fechados com energia e ar comprimido
- ✓ Restaurante
- ✓ Vestiários / Banheiro masculino e feminino
- ✓ Ambulatório
- ✓ Loja
- ✓ Estacionamento para caminhões
- ✓ Estacionamento para carros / motos
- ✓ Heliponto
- ✓ Pista com extensão de 1.240,00 mts
- ✓ Paddock
- ✓ Portaria
- ✓ rampa de acessibilidade

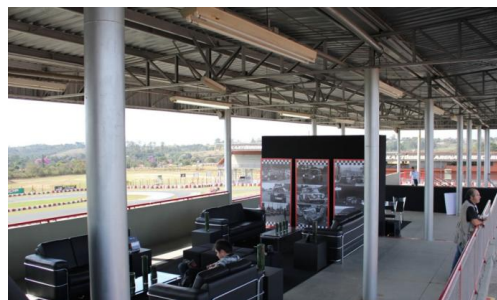

# Perspectiva Auditório

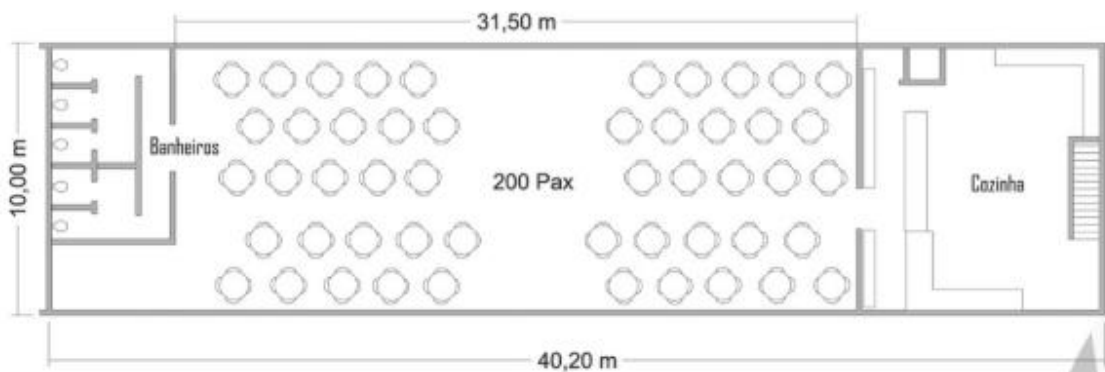
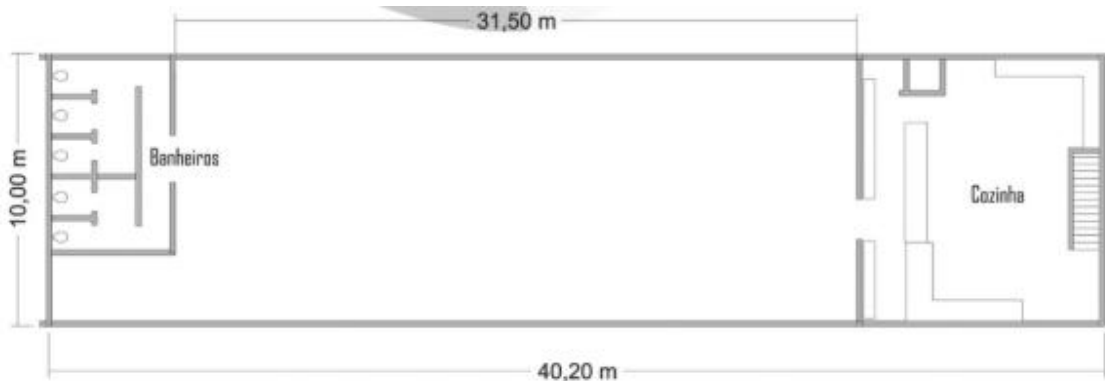
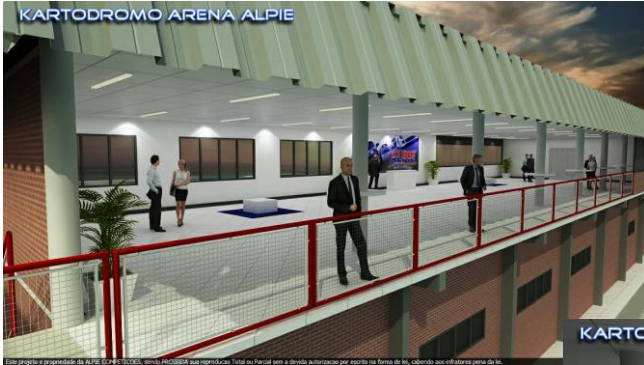

# Perspectiva Box

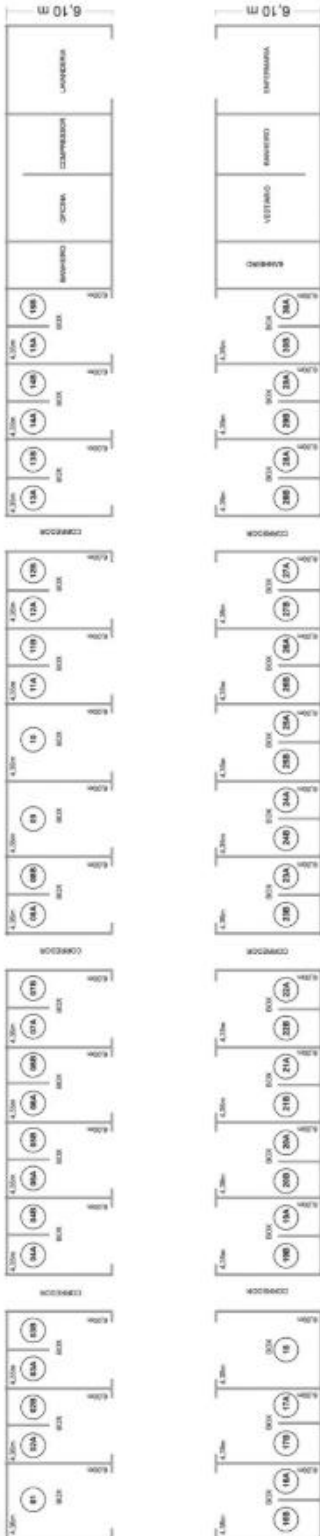

1. Lavanderia
2. Sala de máquinas
3. Banheiro masc. e fem.
4. Ambulatório
5. Vestiário
6. almoxarifado

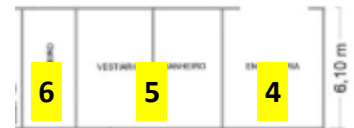
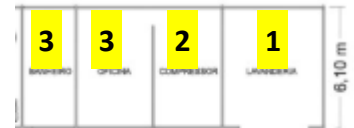

Box pequeno      Box grande

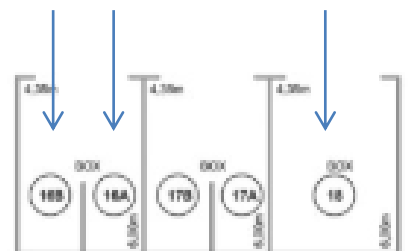

# Perspectiva Paddock



# Perspectiva Acessibilidade

- 3 banheiros PNE
- Vagas demarcadas
- Rampas de acesso ao Paddock, Arquibancada e Auditório

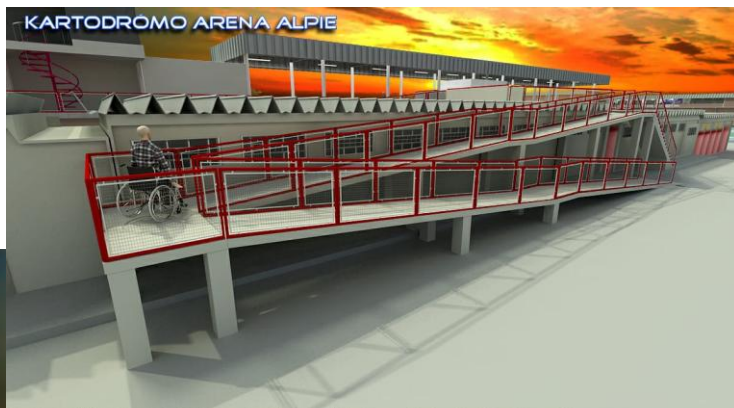

# **Sejam Bem-vindos ao Kartódromo Arena em Itu**

**As Possibilidades são inúmeras,  
Os benefícios são reais!**

**Estamos à disposição para uma reunião.**

**Erika Piedade**

Adm – novos negócios

Escritório sede SP

Av. Senador Teotônio Vilela, 373 – Interlagos

Arena Itu

Rua Paula Donaio Schincariol, 801 – Atrás da fábrica da  
Heineken

(11) 5666.3007 / (11) 5666.6041 / (11) 9.7276.4333

[erikapedade@alpie.com.br](mailto:erikapedade@alpie.com.br)

[Kartodromodeitu@alpie.com.br](mailto:Kartodromodeitu@alpie.com.br)

Site em desenvolvimento